







Cable configurator

PADCON Float Controller CI

Cable variants

Kabel No.	Kabel type	Length	Connections	Description
①		0,5m	open / plug MC4	Inverter connection cable (Measurement +/- Pull up)
②		1m	socket MC4 / plug MC4	FC or MC connection cable with encapsulated 5A fuse (Module side with positive voltage)
③		3m / 5m / 10m	socket MC4 / plug MC4	Distance cable (Measurement + / Pull up)
④		0,5m	socket MC4 / plug MC4	FC or MC connection cable (Pull up)
⑤		0,5m / 3m / 5m / 10m	open / socket MC4	Inverter connection cable (Measurement -)
⑥		3m / 5m / 10m	open / plug MC4	Inverter connection cable (Measurement +/- Pull up)
⑪		0,4m	plug MC4 / plug MC4 socket MC4	Y- cable +

Order

Kabel No.	Length	Number

Kabel No.	Length	Number

Please complete the form and send it to PADCON GmbH by e-mail, fax or post.

Cable configurator

PADCON Float Controller CI

Float Controller

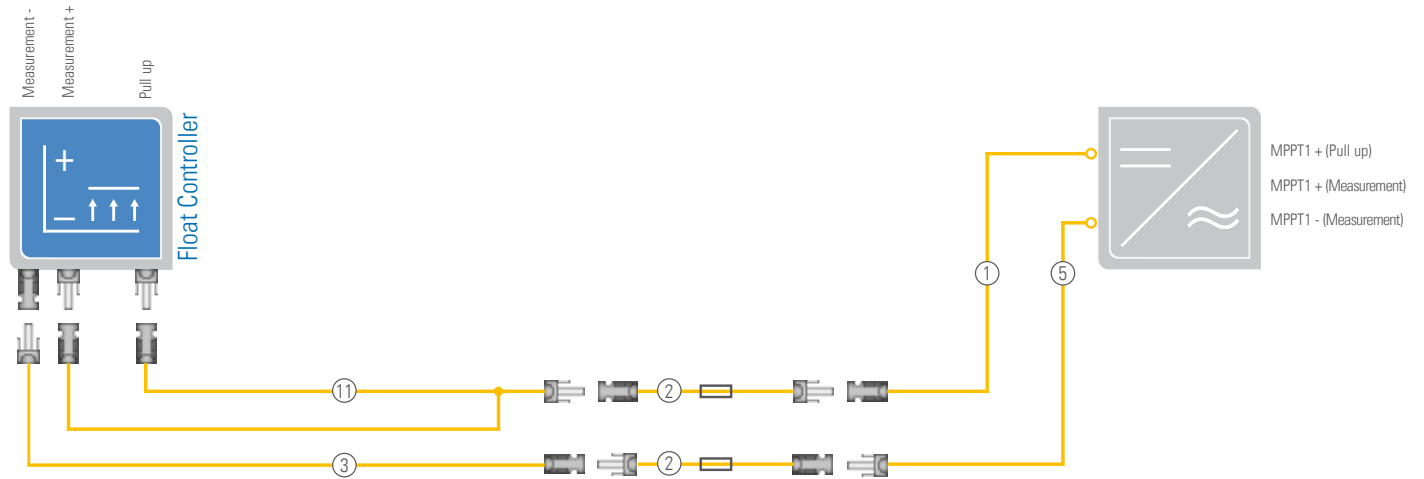

Float Controller with Multi Connector

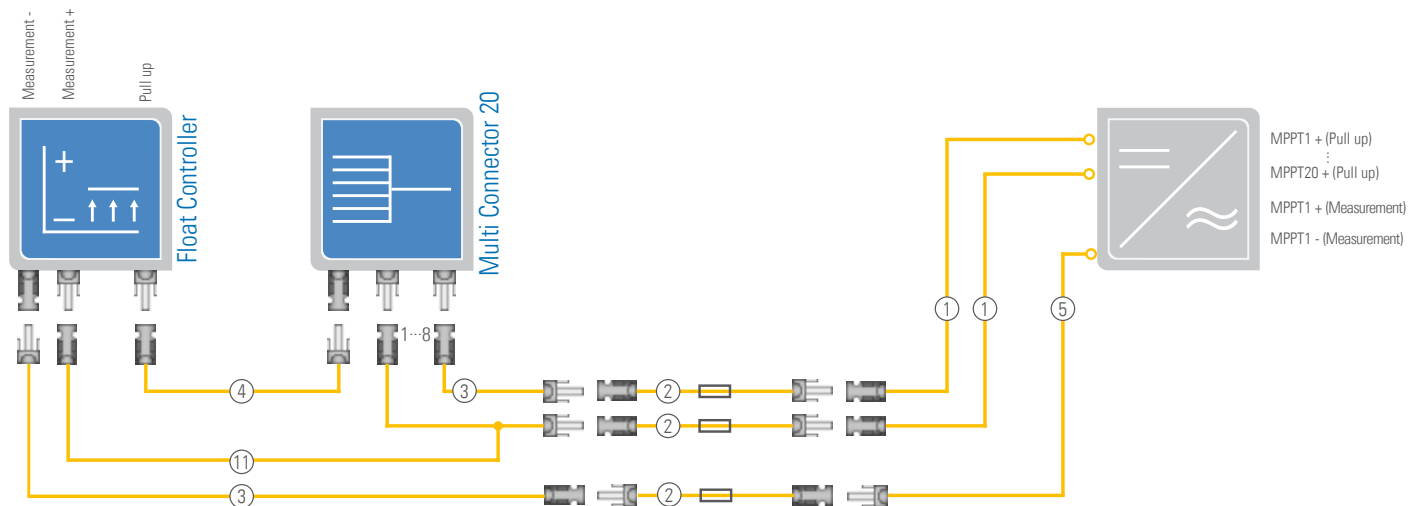

Compact Station

