

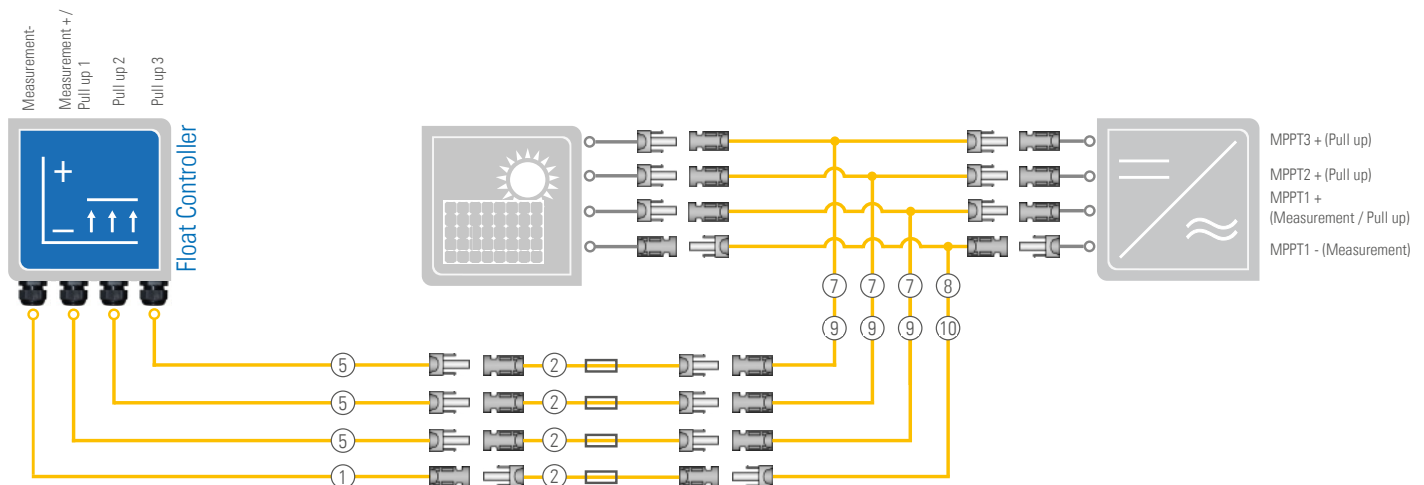







Cable configurator

PADCON Float Controller SI

Float Controller



Cable variants

| Cable no. | Cable type | Length | Connections | Description |
|-----------|---|-----------------------|---|--|
| ① |  | 0,5m / 1,5m / 4m / 6m | open / plug MC4 | Inverter connection cable (Measurement + / Pull up) |
| ② |  | 1m | socket MC4 / plug MC4 | FC or MC connection cable with encapsulated 5A fuse (Module side with positive voltage) |
| ⑤ |  | 0,5m / 3m / 5m / 10m | open / socket MC4 | Distance cable (Measurement + / Pull up) |
| ⑦ |  | 0,4m | plug MC4 / socket MC4 plug MC4 | Y-cable + |
| ⑧ |  | 0,4m | socket MC4 / plug MC4 socket MC4 | Y- cable - |
| ⑨ |  | 0,4m | Sunclix plug / socket MC4 Sunclix plug | Y- cable + |
| ⑩ |  | 0,4m | Sunclix socket / plug MC4 Sunclix socket | Y- cable - |

Please complete the form and send it to PADCON GmbH by e-mail, fax or post.

Cable configurator

PADCON Float Controller SI

Order

| Cable no. | Length | Amount |
|-----------|--------|--------|
| | | |
| | | |
| | | |
| | | |
| | | |
| | | |

| Cable no. | Length | Amount |
|-----------|--------|--------|
| | | |
| | | |
| | | |
| | | |
| | | |
| | | |

Please complete the form and send it to PADCON GmbH by e-mail, fax or post.